



Steelect  
S.A. de C.V.



# Steelect

*Design, Fabrication and Mechanical  
Engineering Solution*





## ¿Quiénes Somos?

*About us?*

**Steelect** es una compañía que provee **servicios integrales** para el sector Oil&Gas.

Proveemos desde diseño e ingeniería, suministro de materiales certificados, hasta la construcción e instalación con personal calificado.

---

*Steelect is a company that provides comprehensive services for the Oil & Gas sector.*

*We provide from design and engineering, supply of certified materials, to construction and installation with qualified personnel.*





## Misión / Mission

Cumplir o exceder constantemente nuestro compromiso y requisitos de los clientes con seguridad, calidad, excelencia y protección del medio ambiente.

Ofreciendo un valor financiero sostenible con un respaldo de clase mundial, donde nuestra mano de obra y servicio local cumplen con las más altas certificaciones y calificaciones.

*Consistently meet or exceed our commitment and customer requirements with safety, quality, excellence and environmental protection.*

*Offering sustainable financial value with world-class support, where your local labor and service meet the highest certifications and qualifications.*

## Visión / Vision

Ser un proveedor mundial suministrando una amplia gama de servicios y soluciones integrales en todas nuestras líneas de negocio.

*To be a global provider providing a wide range of services and comprehensive solutions in all our lines of business.*



# Nuestro Patio de Fabricación y Oficinas

*Our Fabrication Yard and Offices*

---







# Servicios

## Services

- **Diseño e Ingeniería**  
*Design and Engineering*
- **Fabricación, Soldadura y Maquinados**  
*Fabrication, Welding and Machining*
- **Suministro de Personal Calificado para Costa Afuera**  
*Supply of Qualified Personnel for Offshore*
- **Mantenimiento Mecánico**  
*Mechanical Maintenance*
- **Pruebas de Carga y Presión**  
*Load and Pressure Tests*
- **Sand Blast y Pintura**  
*Sandblasting and Painting*
- **Renta de Equipos**  
*Equipment Rental*  
Compresores y Generadores / *Compressors and Generators*  
Maquinas de Soldar / *Welding machines*  
Rack y Canastas / *Rack and Baskets*  
Contrapeso / *Counterweight*
- **Suministro de Materiales y Consumibles**  
*Supply of Materials and Consumables*



# Nuestros Clientes / Our Clients



James Fisher and Sons plc  
Marine Services Worldwide



blue marine



BME SUBTEC





  
**Steelect**  
**PROYECTOS**  
*Projects*

---





**Diseño, Ingeniería y Fabricación / Design, Engineering and Fabrication.**

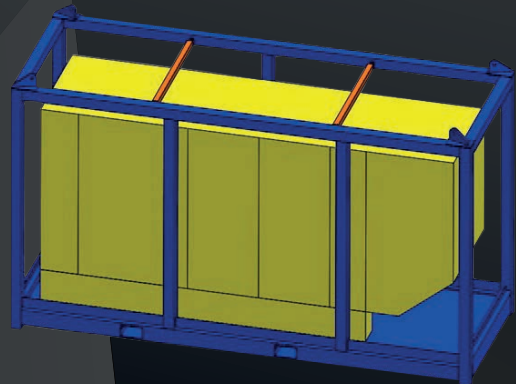
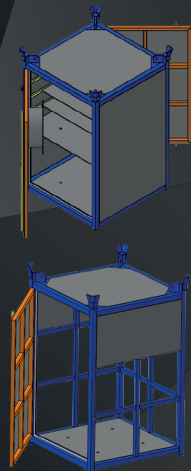
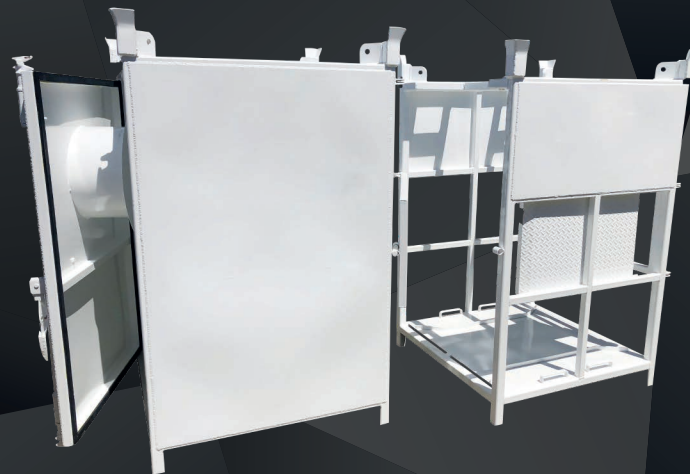



## **Diseño, Ingeniería, Fabricación e Instalación de Patín para Transformadores** / *Design, Engineering, Manufacturing and Installation of Skates for Transformers.*

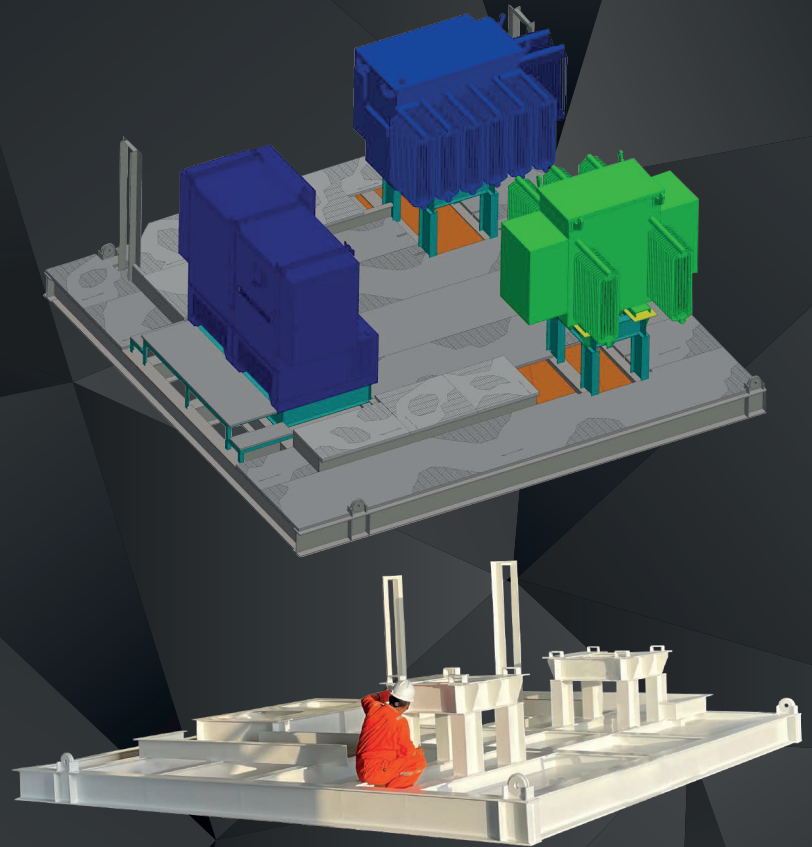



## Interconexión de Pozo (Amarre de Pozo) / *Well Interconnection.*







## Reparación de Motores / *Engine Overhaul.*





## Prefabricado de Spooles / Prefabricated Spools.

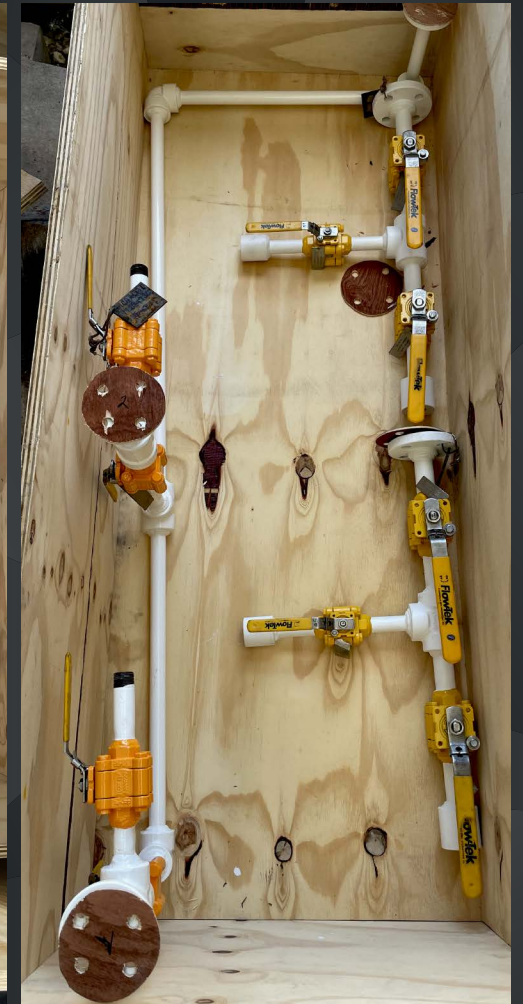





## Spreader Bar Rental.









## **Pintura de Pluma de Grúa / *Painting of Crane Boom.***





**Mantenimiento, Prueba y Pintura de Contenedores /**  
*Maintenance, Load Testing and Painting of Containers.*







# Servicio de Aplicación de Protección Anticorrosiva Onshore y Offshore / *Onshore and offshore corrosion protection application services.*

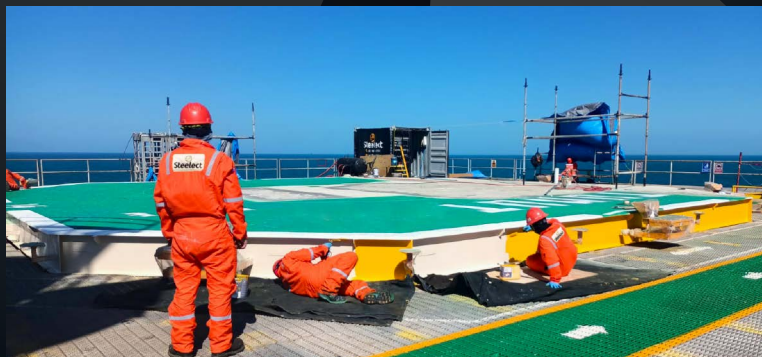





## Servicio de Rope Access / *Rope Access Service.*

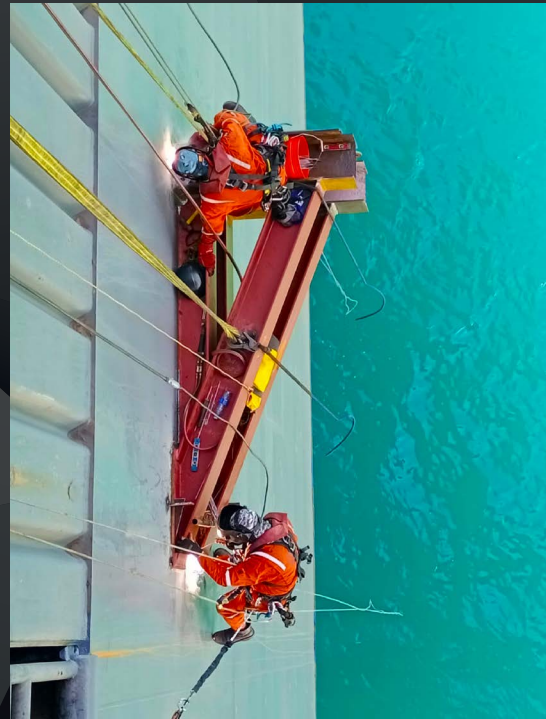





## Renta de Contenedores y Rack / Rent of Containers and Rack.

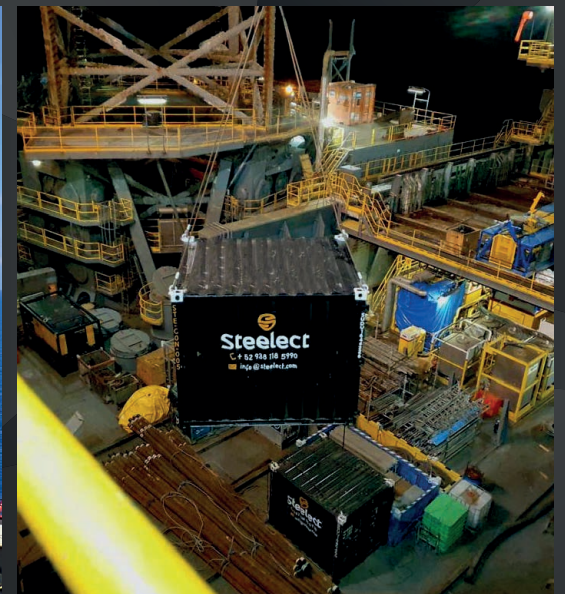



## Ensamble, Pruebas de Funcionamiento, Izaje y Amarres Marinos / *Assembly, Functional Testing, Lifting and Marine Moorings.*

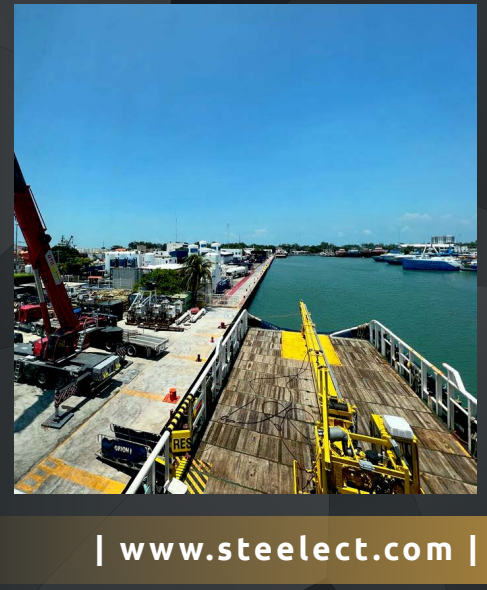
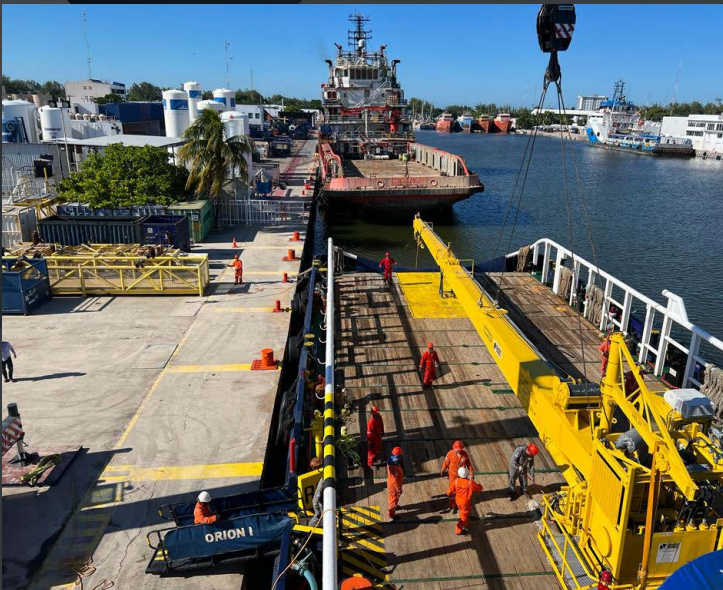
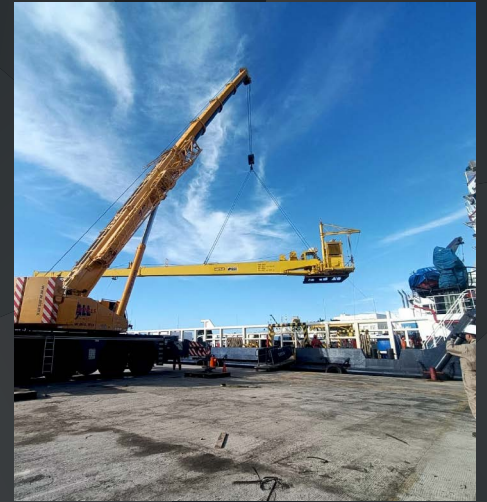



## Instalación de Grúa Costa Afuera / *Offshore Crane Installation.*







# Fabricación e Instalación Costa Afuera de Descansos / *Offshore rest manufacturing and installation.*

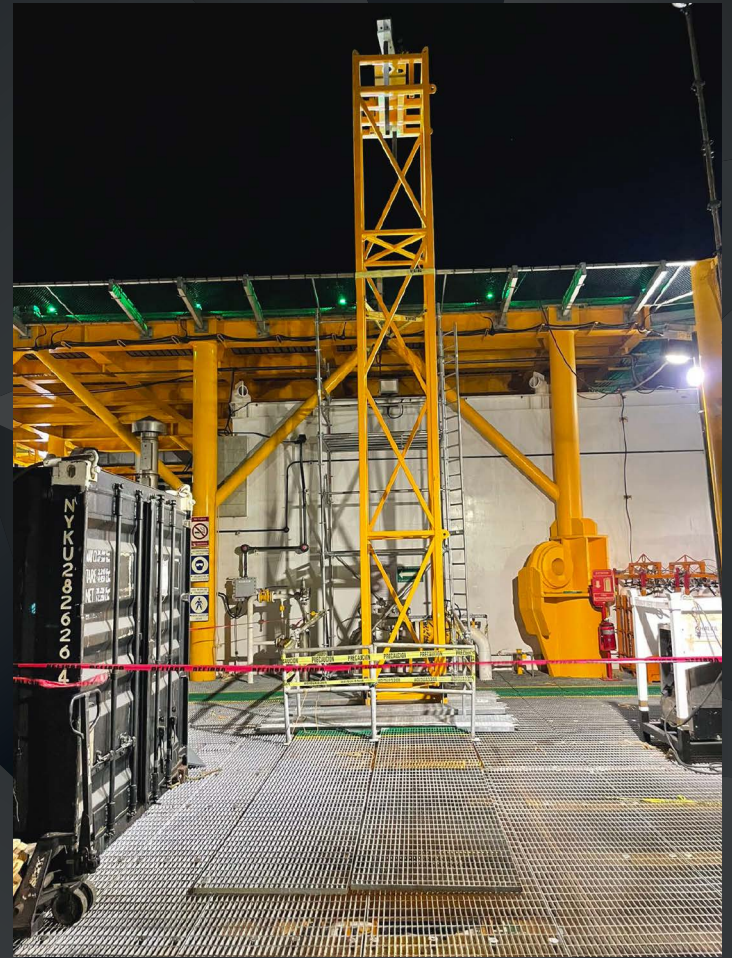
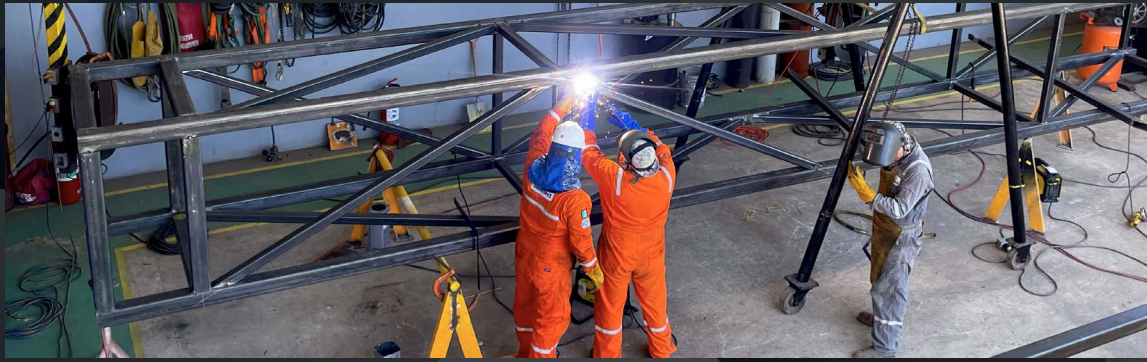





# Servicio de Soldadura de Pedestales / *Pedestal Welding Service.*

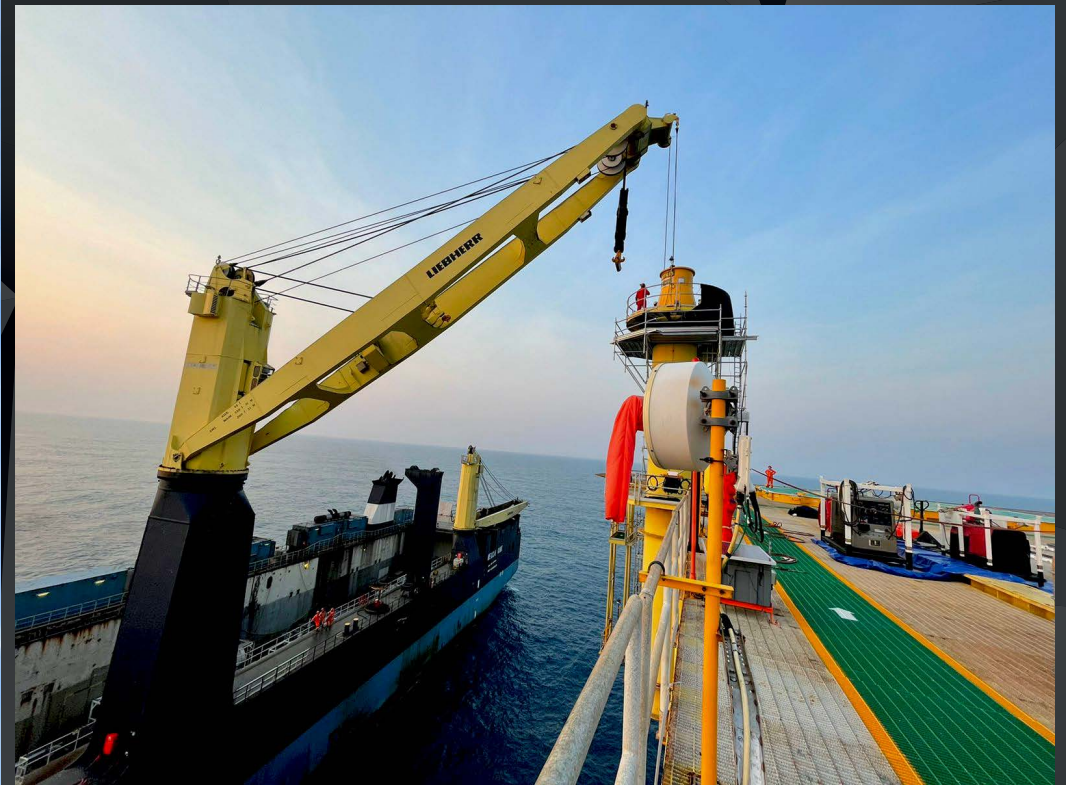





## Instalación de Pasillo Perimetral de Pedestal / *Pedestal* *perimeter hallway installation.*





**Instalación Modular de Grúa / *Modular Crane Installation.***

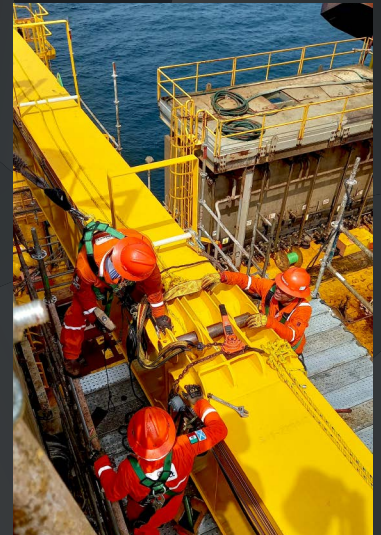





# Steelect

## Reparación de Hallazgos Estructurales en Grúa Principal

*Structural Findings Repair on Main Crane*

Embarcación garzprom-2 / Vessel garzprom-2.





## Proyectos con TIG (Tungsten Inert Gas) / *Projects with TIG.*





## Área de Soldadura TIG: Excelencia Exclusiva en Soldaduras de Alta Calidad / *TIG Welding Area: Exclusive Excellence in High-Quality Welding.*

**Nuestro lugar de fabricación y soldadura con TIG es un espacio dedicado a la excelencia en la producción y unión de materiales metálicos garantizando la creación de productos de alta calidad con precisión y atención al detalle. / *Our TIG manufacturing and welding facility is a space dedicated to excellence in the production and joining of metallic materials, ensuring the creation of high-quality products with precision and attention to detail.***





## Proyectos con TIG (Tungsten Inert Gas) / *Projects with TIG.*

Maquinado de Bridas Acero Inoxidable. / *Stainless Steel Flange Machining.*





## Proyectos con TIG (Tungsten Inert Gas) / *Projects with TIG.*

Unión de Juntas Cunifer. / *Joint Union Cunifer.*



Reparación de Manguera  
Inox. / *Stainless Steel  
Hose Repair.*







## Servicio de Sistemas de Medición de Tuberías

### *Pipeline Measurement Systems Service*

**Ofrecemos una solución precisa y eficiente para garantizar la exactitud en cada proyecto. Con la estación total de Leica System y Automet Fab, podemos realizar mediciones detalladas y confiables en todo tipo de tuberías. Brindando datos precisos para planificar y ejecutar trabajos de manera eficiente, asegurando resultados de alta calidad y satisfacción. / We provide a precise and efficient solution to ensure accuracy in every project. With the Leica System total station and Automet Fab, we can conduct detailed and reliable measurements on all types of pipelines. Providing precise data to plan and execute tasks efficiently, ensuring high-quality results and satisfaction.**



- **Estudios y Análisis Completos en Menos de 5 Minutos por Carrete, con Informes Inmediatos. / Comprehensive studies and analysis in under 5 minutes per reel, with immediate reports.**
- **Los informes digitales 3D garantizan la integridad de los datos, que se pueden verificar cualquier etapa del proceso de medición. / 3D digital reports ensure data integrity, which can be verified at any stage of the measurement process..**
- **Precisión de medición dentro de 0,3 mm. Measurement accuracy within 0.3 mm.**



## Servicio de Sistemas de Medición de Tuberías

### Pipeline Measurement Systems Service

#### Spool 04-SW-A7D-150613

Fitting	Part	X	Y	Z
...	Global Flange Geometry in Degrees	in mm for Information		
F01	4" Weldneck RF 150# 10	0.0	0.0	0.0
...	Az=0.0°, Zn=90.0°, Bh=0.0°	[0.0]	[0.0]	(0.0)
WP03		0.0	-275.0	0.0
E01	4" 90.0° Long Radius 10	0.0	-670.0	0.0
E02	4" 90.0° Long Radius 10	585.0	-670.0	0.0
E03	4" 90.0° Long Radius 10	585.0	-670.0	935.0
F02	4" Weldneck RF 150# 10	698.9	-464.5	935.0
...	Az=29.0°, Zn=90.0°, Bh=0.0°	[N/A]	[0.0]	(0.0)
F03	SHOE BASE PLATE 300 x 100 x 15.9	0.0	-275.0	-143.0
...	Az=0.0°, Zn=180.0°, Bh=0.0°	[N/A]	[0.0]	(0.0)

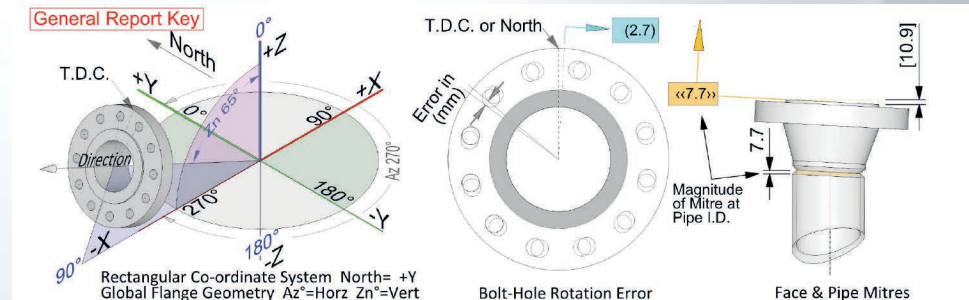
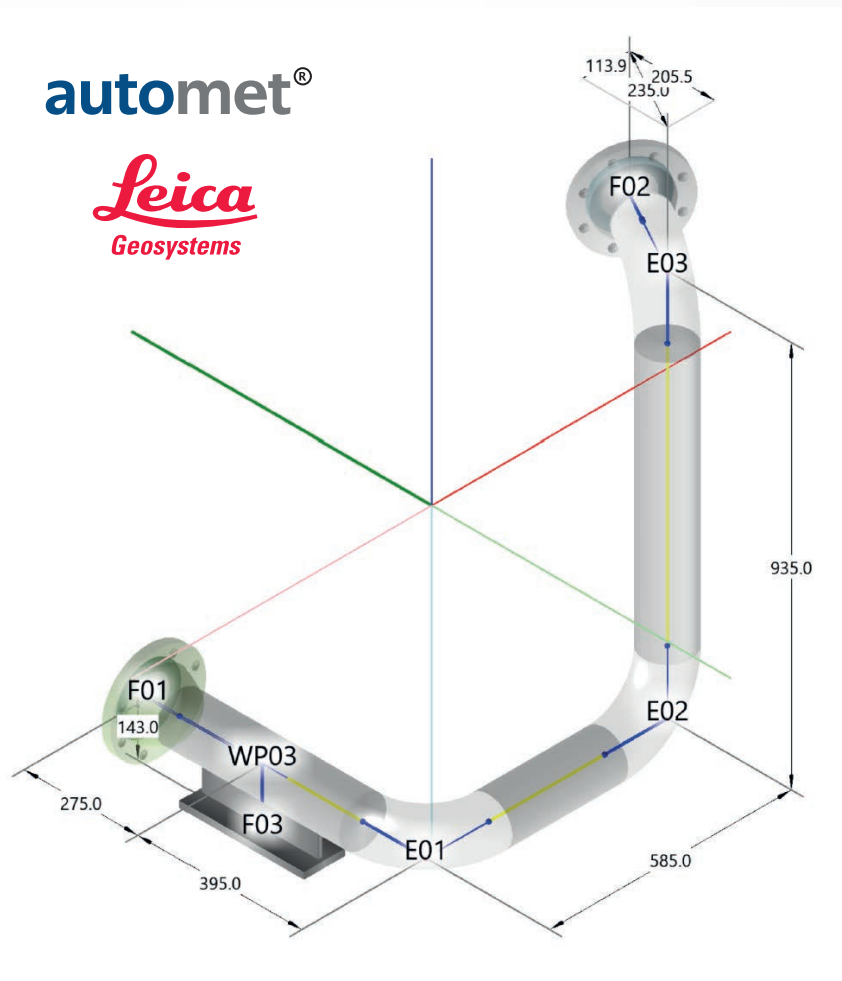





# Steelect

## Servicio de Corte con Chorro de Agua

*Waterjet Cutting Services*

**Revitalizamos el arte del corte con chorro de agua: Nuestra innovadora solución sobresale en tecnología y diseño, marcando un nuevo estándar en el sector.** / *Revitalizing the art of waterjet cutting: Our innovative solution excels in technology and design, setting a new standard in the industry.*

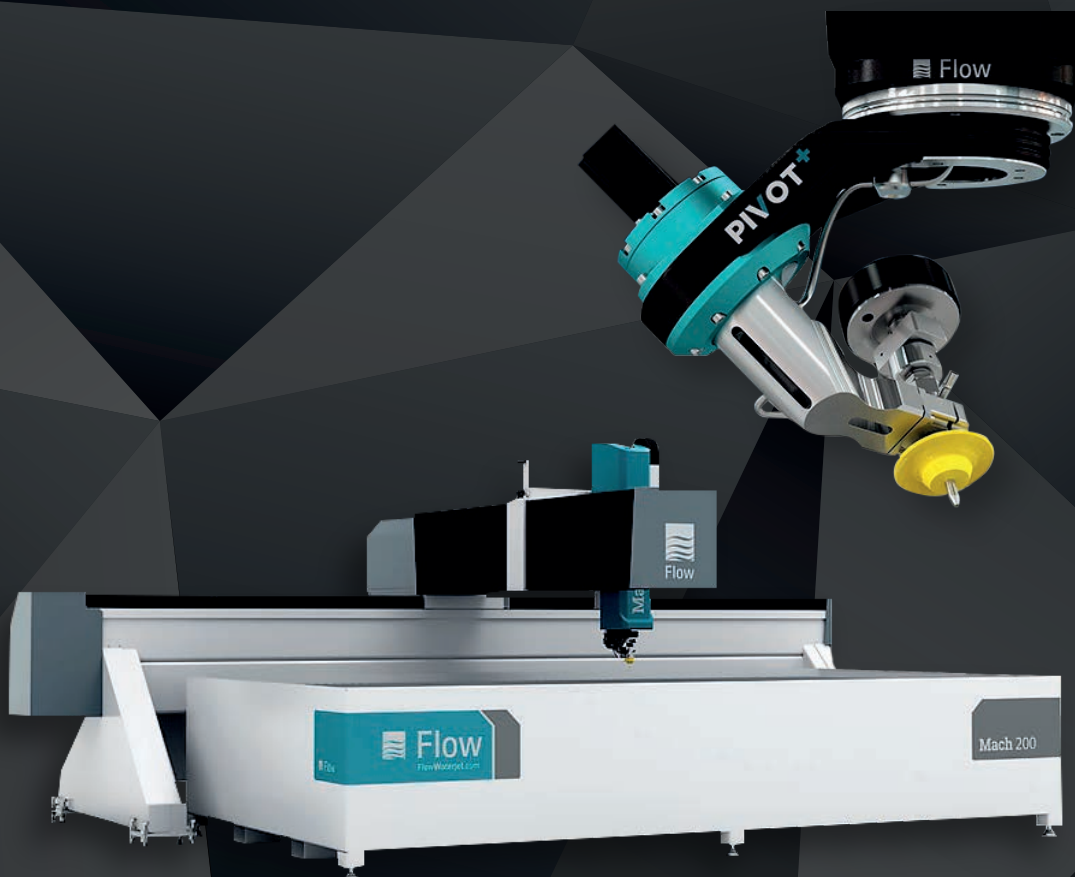





# Steelect

## Servicio de Corte con Chorro de Agua

*Waterjet Cutting Services*

**Lo mejor para estas aplicaciones: rieles, composiciones, piedra y azulejo, alimentos, vaso, apilado grueso, papel, precisión, biseles, etc. / Best for these applications: rails, composites, stone and tile, food, glass, stacking, thick, paper, precision, bevels, etc.**



| [www.steelect.com](http://www.steelect.com) |





## Nuestro Equipo / *Our Team.*

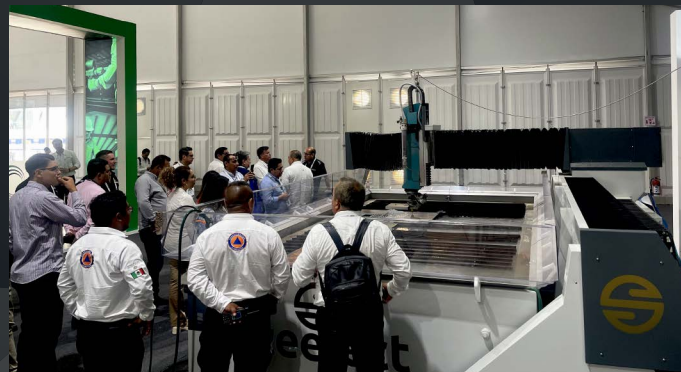





## Contáctanos

*Contact Us*

---

### Philip Davidson

 [pdavidson@steelect.com](mailto:pdavidson@steelect.com)

 938 400 8954

### Hector Soto

 [hsoto@steelect.com](mailto:hsoto@steelect.com)

 833 436 6508

### Fredis Aranda

 [faranda@steelect.com](mailto:faranda@steelect.com)

 938 157 0374

### Manuel Arevalo

 [jarevalo@steelect.com](mailto:jarevalo@steelect.com)

 938 185 7985



Steelect, Calle Amado Nervo, Colonia San Nicolás S/N  
Cd. del Carmen Camp. México CP24118